

Telecentric Lenses



- Zoom telecentric system.
- Single-Sided telecentric lenses.
- Single-Sided telecentric accessories.
- Video telecentric lenses.
- Double-Sided telecentric lenses.
- Double-Sided telecentric illumination accessories.

Stocked, Distributed, and Supported by

SENSORS
INCORPORATED

507 Kelsey Street • Delano, MN 55328
Phone 763-972-1040 Fax 763-972-1041
Toll Free 888-920-0939
Sensorsincorporated.com

 **NAVITAR**[®]

Telecentric Lenses



Navitar Telecentric Lenses

Navitar offers a family of high-performance telecentric lenses for use in machine vision, metrology and precision gauging applications. All provide low optical distortion and a high degree of telecentricity for maximum, accurate image reproduction, particularly when viewing three-dimensional objects.

Benefits of Telecentric Lenses

One of the most important benefits of a telecentric lens is that image magnification does not change as object distance varies. A telecentric lens views and displays the entire object from the same prospective angle, therefore, three-dimensional features will not exhibit the perspective distortion and image position errors present when using a standard lens. Objects inside deep holes are visible throughout the field, undistorted, therefore, telecentric lenses are extremely useful for inspecting three-dimensional objects or scenes where image size and shape accuracy are critical.



Choose the Best Lens Option for Your Needs

Our machine vision telecentric lenses include the 12X Telecentric Zoom system, the TC-5028 and TEC-55 telecentric video lens. Our single-sided lenses, the Invarigon-R™, Macro Invaritar™, ELWD Macro Invaritar™ and Invaritar Large Field telecentric lenses are available with several different accessories that enhance the performance of the lenses. They include teleconverters, right angle attachments, fiber bundle collimators and lens mounting brackets. Our Double-Sided series of lenses are telecentric in both the object and image space and have optional illumination accessories to provide a bright, even illumination that will compliment the performance of the lenses.

Zoom Telecentric System

The World's First Parfocal Telecentric Zoom Lens

The 12X Telecentric Zoom system allows users to reach a true telecentric condition to within less than 0.3° while maintaining constant perspective and magnification. This means that even if the object is slightly out of focus, the size of the image will not change. The 12X Telecentric Zoom provides field coverage from 50 mm down to 4 mm and the coaxial illumination allows clear viewing, even when working with mirror-like surfaces. Also available without coaxial illumination.

Wide Magnification Range and Ultra Long Working Distance

In the past, a telecentric lens was defined as having fixed magnification. Not anymore! The Navitar 12X Telecentric Zoom lens allows you to zoom in and focus over a wide variety of magnifications with a higher level of accuracy than you ever thought possible. The 12X Telecentric Zoom provides adjustable focal lengths over a 0.16X to 1.94X magnification range. You no longer have to be limited by telecentric lenses that only offer fixed magnification. Now you have field coverage from 50 mm down to 4 mm at a 188 mm working distance.

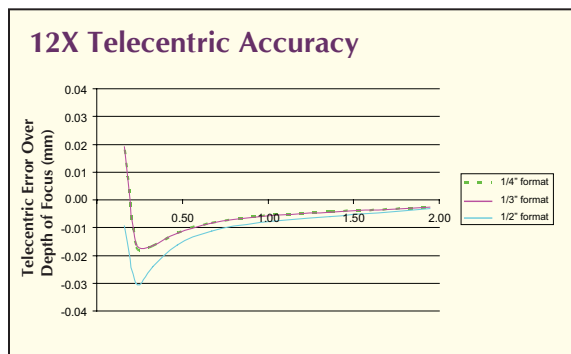

No Need to Change Lenses

The easily adjustable field of view and magnification allow our Navitar 12X Telecentric lens to adjust to meet your exact requirements. It's no longer necessary to change lenses, mix and match base lenses with attachment lenses or recalibrate. One lens, the 12X Telecentric, really does it all! Straight, as well as right angle, versions allow OEM designers to best fit the systems to their mechanical design.

Wide Range of Applications

Specifically designed for precise dimensional measurement of objects or pattern recognition, the 12X Telecentric Zoom has many applications. It's ideal for measuring three-dimensional objects with deep features, such as well plates, electrical connector pins, and other precision parts. It's also the perfect lens for viewing inconsistently placed parts on a conveyor belt.

12X Telecentric Lens Specifications

Mag.	Telecentric Error (degrees)			Object N.A.	Image N.A.	Object Depth of Focus (mm)	Telecentric Error (mm)			Object Size			Approx. MTF (lp/mm)	Resolvable Features (microns)
	1/4"	1/3"	1/2"				1/4"	1/3"	1/2"	1/4"	1/3"	1/2"		
0.16	0.05	0.06	-0.03	0.005	0.032	38.8	0.018	0.020	-0.009	25.0	37.3	49.7	15	33
0.23	-0.10	-0.09	-0.18	0.007	0.031	19.4	-0.017	-0.016	-0.030	17.4	26.1	34.8	22	23
0.33	-0.19	-0.18	-0.27	0.010	0.030	10.3	-0.016	-0.016	-0.024	12.1	18.2	24.3	30	17
0.47	-0.23	-0.23	-0.31	0.013	0.028	6.0	-0.012	-0.012	-0.016	8.5	12.8	17.0	39	13
0.67	-0.25	-0.25	-0.34	0.016	0.024	3.8	-0.008	-0.008	-0.011	5.9	8.9	11.9	49	10
0.96	-0.27	-0.27	-0.36	0.020	0.021	2.6	-0.006	-0.006	-0.008	4.2	6.3	8.4	59	8
1.36	-0.29	-0.29	-0.38	0.024	0.017	1.8	-0.004	-0.005	-0.006	2.9	4.4	5.9	71	7
1.94	-0.25	-0.24	-0.29	0.028	0.015	1.3	-0.003	-0.003	-0.003	2.1	3.1	4.1	84	6

Distortion < 0.1% for all magnifications. Working Distance = 188 mm for all magnifications.

Single-Sided Telecentric

Invarigon-R™

The Invarigon-R™ family of gauging lenses provides telecentric imaging with a wide selection of magnifications. Invarigon-R™ gauging lenses are the most cost-effective choice for critical inspection and metrology imaging applications.



Features

- Telecentric performance ($<0.2^\circ$ chief ray angle over the entire object field) allows precise gauging of 3-dimensional objects.
- Large selection of magnifications covers most applications.
- Lockable aperture adjusts to select the required depth of field.
- Fine focus adjustment provides sharper images.
- Rugged single-piece design stands up to harsh industrial environments.
- High-performance multi-layer coatings provide the highest image clarity, especially for back-lit applications.
- Standard C-mount camera interface.

Invarigon-R™ Lens Specifications

Part Number	Mag. (nominal)	Length		Diameter		Working Distance		Maximum Object Dimensions (in.) ¹			Min f# ²	Min. Operating f# ³	Depth of Field (in.) ⁴
		mm.	in.	mm.	in.	mm.	in.	1/3" CCD	1/2" CCD	2/3" CCD			
59 LGU 013	0.13X	217	8.5	80	3.2	190	7.4	1.02 x 1.36	1.36 x 1.81	N/A	1.4	4	1.66
59 LGU 016	0.16X	176	6.9	70	2.8	150	6.0	0.82 x 1.09	1.09 x 1.45	N/A	1.4	5.6	1.06
59 LGU 018	0.18X	154	6.1	61	2.4	130	5.2	0.71 x 0.95	0.95 x 1.27	N/A	1.4	5.6	0.81
59 LGU 022	0.22X	170	6.7	70	2.8	150	6.0	0.59 x 0.78	0.78 x 1.04	1.07 x 1.43	1.6	8	0.54
59 LGU 025	0.25X	148	5.8	61	2.4	130	5.2	0.51 x 0.68	0.68 x 0.91	0.94 x 1.25	1.6	8	0.42
59 LGU 029	0.29X	126	4.9	54	2.1	110	4.4	0.44 x 0.59	0.58 x 0.78	0.80 x 1.07	1.6	8	0.31
59 LGU 031	0.31X	171	6.7	70	2.8	150	6.0	0.41 x 0.54	0.54 x 0.72	0.74 x 0.99	2.3	8	0.27
59 LGU 036	0.36X	149	5.9	61	2.4	130	5.2	0.36 x 0.47	0.48 x 0.63	0.66 x 0.87	2.3	8	0.20
59 LGU 042	0.42X	126	5.0	54	2.1	110	4.4	0.31 x 0.41	0.41 x 0.54	0.56 x 0.74	2.3	8	0.15
59 LGU 050	0.50X	105	4.1	54	2.1	90	3.6	0.26 x 0.34	0.34 x 0.45	0.47 x 0.62	2.3	11	0.10

¹The maximum object dimensions shown in the table are 90% of the theoretical maximum dimensions, providing a safety factor for magnification and alignment errors.

²Image-side working f/# with lens aperture fully open. For combinations with teleconverters, the minimum image-side f-number is increased by the teleconverter magnification.

³Lenses operated at smaller f/# may show reduced resolution, especially near the edge of the field of view.

⁴Depth of field is calculated at f/11 for lenses with minimum operating f/# $< f/16$ (f/22 for all others) and for 30- μ m allowable blur at the image (camera) plane.

Note: Distortion is less than 1.2% for all lenses. Contact Navitar for specific distortion characteristics for a particular lens.

Accessory Note:

Teleconverter accessories can be used with select Invarigon-R™ lenses (59 LGU 031, 59 LGU 036, 59 LGU 042, 59 LGU 050) to increase magnification by a factor of 1.5x or 2.0x depending on the lens combination. Teleconverters cannot be used with certain types of 3-CCD color cameras.

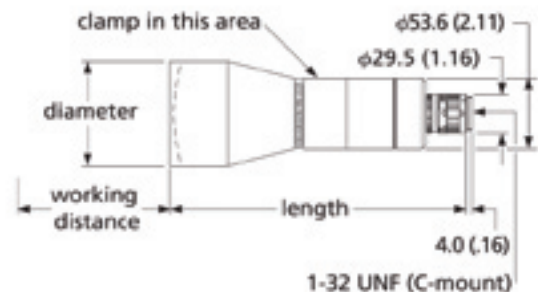

dimensions in mm (in.)

Single-Sided Telecentric

Macro Invaritar™

The Macro Invaritar™ telecentric gauging lenses provide exceptional telecentric imaging performance and are the best choice for machine vision applications involving significant space limitations.



Features

- Telecentric performance ($<0.25^\circ$ chief ray angle over the entire object field) allows precise gauging of 3-dimensional objects.
- Low distortion ($<0.1\%$ over the entire object field) provides highly accurate images.
- Small footprint to fit into restricted spaces.
- Rugged single-piece design stands up to harsh industrial environments.
- Lockable aperture adjusts to select the required depth of field.
- Standard C-mount camera interface.

Macro Invaritar™ Lens Specifications

Part Number	Mag. ¹ (nominal)	Length		Diameter		Working Dist.		Maximum Object Dimensions (mm.) ²			f# Range ³	Depth of Field (mm) ⁴
		mm.	inches	mm.	inches	mm.	inches	1/3" CCD	1/2" CCD	2/3" CCD		
59 LGM 205	0.5x	104	4.1	42	1.7	48	1.9	6.5 x 8.6	8.6 x 11.5	11.9 x 15.8	12 - 32	3.84
59 LGM 601	1x	110	4.3	32	1.2	46	1.8	3.2 x 4.3	4.3 x 5.8	5.9 x 7.9	6.25 - 32	1.92
59 LGM 602	2x	107	4.2	32	1.2	25	1.0	1.6 x 2.2	2.2 x 2.9	3.0 x 4.0	3.12 - 16	0.48
59 LGM 605	5x	175	6.9	41	1.6	36	1.4	0.6 x 0.9	0.9 x 1.2	1.2 x 1.6	2.5 - 8	0.10

¹Tolerance on specified magnification is $\pm 3\%$.

²The maximum object dimensions shown in the table are 90% of the theoretical maximum dimensions, providing a safety factor for magnification and alignment errors.

³f/# specified in object space.

⁴Depth of field is calculated at largest available for each lens f/# and for a 30- μm allowable blur at the image (camera).

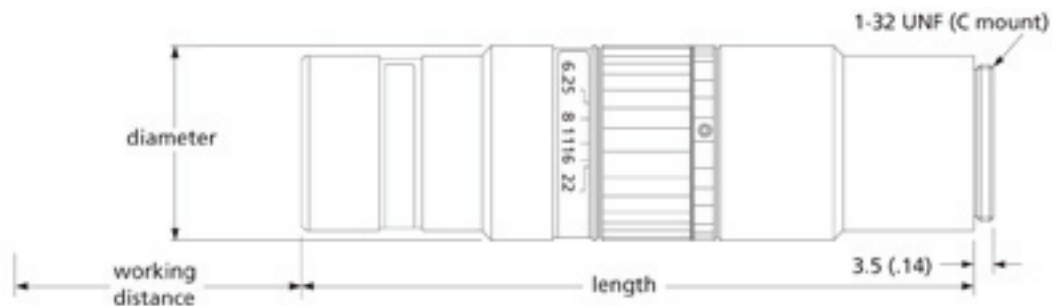

dimensions in mm (in.)

Single-Sided Telecentric

ELWD Macro Invaritar™

ELWD (Extra-Long Working Distance) Macro Invaritar™ telecentric gauging lenses provide exceptional imaging performance and are the best choice for machine vision applications where an extra-long working distance is required.



Features

- Telecentric performance ($<0.1^\circ$ chief ray angle over the entire object field) allows precise gauging of 3-dimensional objects.
- Low distortion ($<0.5\%$ over the entire object field) provides highly accurate images.
- Long working distance permits convenient mounting.
- Rugged single-piece design stands up to harsh industrial environments.
- Lockable aperture adjusts to select the required depth of field.
- Standard C-mount camera interface.

ELWD Macro Invaritar Specifications

Part Number	Mag. (nominal)	Length		WD.		Maximum Object Dimensions (mm.) ¹			f# Range ²	Depth of Field (mm.) ³
		mm.	inches	mm.	inches	1/3" CCD	1/2" CCD	2/3" CCD		
59 LGN 702	2x	186	7.3	116	4.5	1.6 x 2.2	2.2 x 2.9	3.0 x 4.0	5.6 - 16	0.48
59 LGN 703	3x	256	10.1	105	4.1	1.1 x 1.4	1.4 x 1.9	2.0 x 2.6	5.6 - 16	0.32
59 LGN 704	4x	303	11.9	101	4.0	0.8 x 1.1	1.1 x 1.4	1.5 x 2.0	5.6 - 16	0.24
59 LGN 705	5x	362	14.2	98	3.9	0.6 x 0.9	0.9 x 1.2	1.2 x 1.6	5.6 - 16	0.19

¹The maximum object dimensions shown in the table are 90% of the theoretical maximum dimensions, providing a safety factor for magnification and alignment errors.

²f/# specified in object space.

³Depth of field is calculated at largest available for each lens f/# and for a 30- μ m allowable blur at the image (camera).

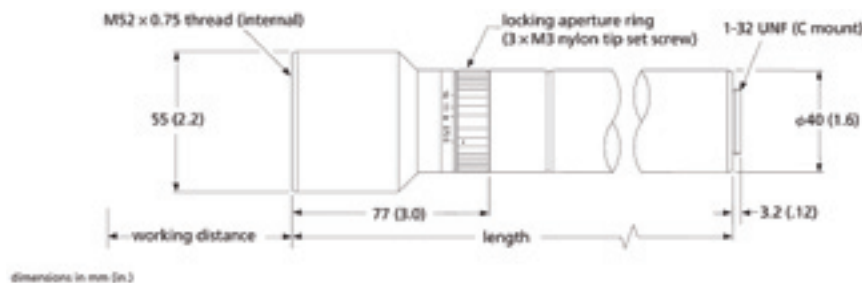

Single-Sided Telecentric

Invaritar™ Large Field

Invaritar™ modular, large-field telecentric gauging lenses provide a wide range of solutions for a variety of machine vision applications. A telecentric lens system is created by combining a base lens with an appropriate attachment lens to achieve the required magnification and field of view.



Features

- Telecentric performance of less than 0.5-degree chief ray angle over the entire object field allows precise gauging of 3-dimensional objects.
- Large selection of base and attachment lenses covers most applications.
- Low distortion provides for highly accurate images.
- Lockable aperture adjusts to select the required depth of field.
- C-mount lenses include fine focus adjustment, providing sharper images.
- High-performance multi-layer coatings provide the highest image clarity, especially for backlit applications.
- Both C-mount and F-mount base lenses are available.

C-mount Base Lenses

Part Number	Length		Diameter		Weight	
	mm.	inches	mm.	inches	kg.	lb.
59 LGC 516	55	2.2	52	2.1	0.15	0.32
59 LGG 925	53	2.1	30	1.2	0.08	0.17
59 LGG 935	46	1.8	30	1.2	0.08	0.17
59 LGG 950	55	2.2	30	1.2	0.08	0.17

Attachment Lenses

Part Number	Length		Diameter		Weight	
	mm.	inches	mm.	inches	kg.	lb.
59 LGH 416	121	4.8	84	3.3	0.64	1.40
59 LGJ 423	206	8.1	121	4.8	1.76	3.87
59 LGL 428	269	10.6	150	5.9	4.00	8.80
59 LGH 431	275	10.8	84	3.3	0.81	1.78

F-mount Base Lenses

Part Number	Length		Diameter		Weight	
	mm.	inches	mm.	inches	kg.	lb.
59 LGB 435	74	2.9	76	3.0	0.04	0.9
59 LGB 450	57	2.2	76	3.0	0.04	0.8
59 LGB 485	68	2.7	82	3.2	0.06	1.3
59 LGB 499	117	4.6	85	3.3	0.08	1.8

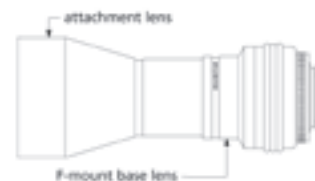
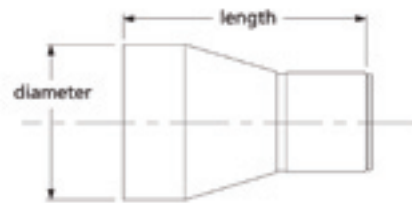
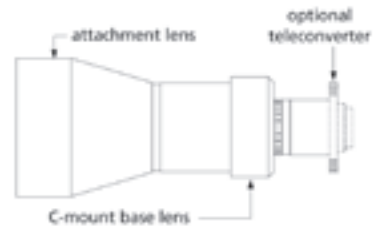

Single-Sided Telecentric

Invaritar™ Large Field (Continued)

C-mount Invaritar™ Large-Field Telecentric Lens Specifications (for camera formats less than or equal to 2/3")

Mag. (nominal)	Working Distance		Maximum Object Dimensions (in.) ¹			Minimum Operating F# Range ²	Depth of Field (in) ³	Part Numbers for Required Optical Components		
	mm.	inches	1/3" CCD	1/2" CCD	2/3" CCD			Base Lens	Attach. Lens	Tele-converter ⁴
0.06x	257	10.1	2.23 x 2.98	N/A	N/A	2.0	7.22	59 LGC 916	59 LGL 428	none
0.07x	203	8.0	1.83 x 2.44	N/A	N/A	2.8	5.0	59 LGC 916	59 LGJ 423	none
0.09x	257	10.1	1.43 X 1.90	1.90 X 2.54	2.62 X 3.49	2.0	3.21	59 LGG 925	59 LGL 428	none
0.10x	152	6.0	1.28 X 1.70	N/A	N/A	5.6	2.60	59 LGC 916	59 LGH 416	none
0.11x	203	8.0	1.17 X 1.56	1.56 X 2.09	2.15 X 2.87	2.8	2.15	59 LGG 925	59 LGJ 423	none
0.11x	302	11.9	1.13 x 1.51	1.51 x 2.01	N/A	2.8	2.15	59 LGG 935	59 LGH 431	none
0.13x	257	10.1	1.02 X 1.36	1.36 X 1.81	1.87 X 2.49	2.0	1.54	59 LGG 935	59 LGL 428	none
0.15x	203	8.0	0.84 X 1.12	1.12 X 1.49	1.54 X 2.05	5.6	1.15	59 LGG 935	59 LGJ 423	none
0.16x	152	6.0	0.82 X 1.09	1.09 X 1.45	1.50 X 2.00	11.0	1.02	59 LGG 925	59 LGH 416	none
0.16x	302	11.9	0.79 X 1.06	1.06 X 1.41	1.45 X 1.94	2.8	1.02	59 LGG 950	59 LGH 431	none
0.18x	257	10.1	0.71 X 0.95	0.95 X 1.27	1.31 X 1.74	5.6	0.80	59 LGG 950	59 LGL 428	none
0.22x	152	6.0	0.58 X 0.78	0.78 X 1.04	1.07 X 1.42	11.0	0.54	59 LGG 935	59 LGH 416	none
0.22x	203	8.0	0.59 X 0.78	0.78 X 1.05	1.08 X 1.44	5.6	0.54	59 LGG 950	59 LGJ 423	none
0.24x	302	11.9	0.53 X 0.70	0.07 X 0.94	0.97 X 1.29	4.0	0.45	59 LGG 950	59 LGH 431	59 LGZ 415
0.27x	257	10.1	0.48 X 0.64	0.63 X 0.85	0.87 X 1.16	11.0	0.36	59 LGG 950	59 LGL 428	59 LGZ 415
0.31x	152	6.0	0.41 X 0.54	0.54 X 0.72	0.75 X 1.00	11.0	0.27	59 LGG 950	59 LGH 416	none
0.32x	302	11.9	0.39 X 0.53	0.53 X 0.70	0.72 X 0.97	5.6	0.25	59 LGG 950	59 LGH 431	59 LGZ 420
0.33x	203	8.0	0.39 X 0.52	0.52 X 0.70	0.72 X 0.96	5.6	0.24	59 LGG 950	59 LGH 423	59 LGZ 415
0.36x	257	10.1	0.36 X 0.48	0.48 X 0.64	0.66 X 0.87	16.0	0.29	59 LGG 950	59 LGL 428	59 LGZ 420
0.43x	203	8.0	0.29 X 0.39	0.39 X 0.52	0.54 X 0.72	16.0	0.20	59 LGG 950	59 LGJ 423	59 LGZ 420
0.47x	152	6.0	0.27 X 0.36	0.36 X 0.48	0.50 X 0.66	11.0	0.12	59 LGG 950	59 LGH 416	59 LGZ 415
0.63x	152	6.0	0.20 X 0.27	0.27 X 0.36	0.37 X 0.50	16.0	0.10	59 LGG 950	59 LGH 416	59 LGZ 420

1. The maximum object dimensions shown in the table are 90% of the theoretical maximum dimensions, providing safety factor of magnification and alignment errors.
2. Lenses operated at smaller f/# may show reduced resolution, especially near the edge of the field of view.
3. Depth of field is calculated for a 30-μm allowable blur at the image (camera) plane at f/11 (for lenses with minimum operating f-number < f/16) or f/22 (for all others).
4. Teleconverters 59 LGZ 420 and 59 LGZ 415 cannot be used with certain types of 3-CCD color cameras.

Note: Distortion is less than 2% for all lenses. Contact Navitar for distortion characteristics for a specific lens.

Invaritar™ Large-Field C-mount Lens

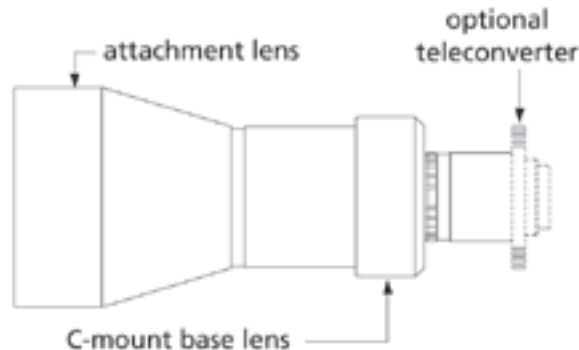

Single-Sided Telecentric

Invaritar™ Large Field (Continued)

F-mount Invaritar™ Large-Field Telecentric Lens Specifications (for camera formats greater than 2/3")

Mag. (nom.)	Working Distance		Maximum Object Dimensions (in.) ¹ 1" CCD	Minimum Operating F# 2	Depth of Field (in) 3	Part # for Required Optical Components	
	mm.	in.				Base Lens	Attach. Lens
0.13x	241	9.5	2.61 x 2.61	16.0	2.24	59 LGB 435	59 LGL 428
0.15x	203	8.0	2.14 X 2.14	16.0	1.68	59 LGB 435	59 LGJ 423
0.18x	241	9.5	1.83 X 1.83	16.0	1.17	59 LGB 450	59 LGL 428
0.22x	140	5.5	1.49 X 1.49	16.0	0.78	59 LGB 435	59 LGH 416
0.22x	203	8.0	1.50 X 1.50	16.0	0.78	59 LGB 450	59 LGJ 423
0.27x	267	10.5	1.19 X 1.19	2.8	0.36	59 LGB 485	59 LGH 431
0.30x	241	9.5	1.07 X 1.07	16.0	0.42	59 LGB 485	59 LGL 428
0.31x	140	5.5	0.04 X 0.04	16.0	0.39	59 LGB 450	59 LGH 416
0.32x	267	10.5	0.01 X 0.01	4.0	0.25	59 LGB 499	59 LGH 431
0.36x	241	9.5	0.91 X 0.91	16.0	0.29	59 LGB 499	59 LGL 428
0.37x	203	8.0	0.88 X 0.88	16.0	0.28	59 LGB 485	59 LGJ 423
0.43x	203	8.0	0.75 X 0.75	16.0	0.20	59 LGB 499	59 LGJ 423
0.53x	140	5.5	0.61 X 0.61	8.0	0.09	59 LGB 485	59 LGH 416
0.63x	140	5.5	0.52 X 0.52	8.0	0.07	59 LGB 499	59 LGH 416

1. The maximum object dimensions shown in the table are 90% of the theoretical maximum dimensions for a 9.2 mm x 9.2 mm (Kodak MegaPlus) format sensor; providing a safety factor of magnification and alignment errors. For larger arrays, contact Navitar.
2. Lenses operated at smaller f/# may show reduced resolution, especially near the edge of the field of view.
3. Depth of field is calculated for a 30- μ m allowable blur at the image (camera) plane at f/11 (for lenses with minimum operating f-number < f/16) or f/22 (for all others).

Note: Distortion is less than 2% for all lenses. Contact Navitar for distortion characteristics for a specific lens.
An accessory C-mount adaptor (59 LGT 101) is required for coupling F-mount Invaritar™ base lenses to a C-mount camera.

Invaritar™ Large-Field F-mount Lens

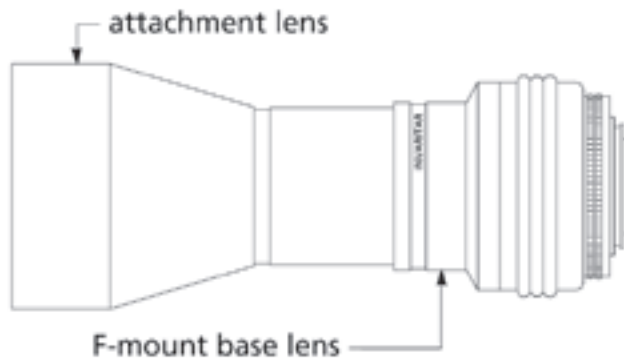

Single-Sided Telecentric Lens Accessories

Navitar offers several different accessories to enhance the performance of their Machine Vision telecentric lenses. These include: teleconverters to increase magnification, right angle attachments for viewing of objects up to 360 degrees about the optical axis, fiber bundle collimators to provide collimated backlighting and anodized mounting brackets for proper mounting of the Invarigon-R™ and Invaritar™ lenses.

Teleconverters

When a closer view of objects is required, use a 59 LGZ-series teleconverter with your Invaritar™ large-field gauging lens. Mounted between the lens and the camera, these teleconverters increase magnification by up to 2.0x. Their compact size has minimum impact on overall lens/camera length. Teleconverters increase lens f-number and contribute to overall image distortion. Teleconverters cannot be used with some 3-CCD color cameras.

Features:

- Rugged, chrome-plated brass construction stands up to harsh environments.
- Multiple-element, anti-reflection coated lens systems provide optimum performance.



HE15-1/2XE teleconverters for C-mount lenses

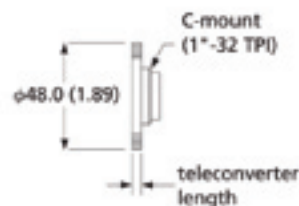

dimensions in mm (in.)

59 LGZ 814/820 teleconverters for F-mount lenses

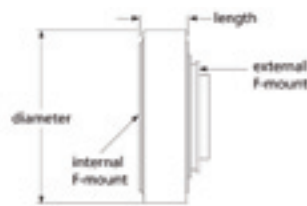

dimensions in mm (inches)

Teleconverter Specifications

Part Number	Mag.	Mount	Applicable Lens	F/# Change	Focal Length Change	Field of View Change	Obj. Dimensions Change	Length (mm./in.)	Diameter (mm./in.)
HE15-1	1.5X	C-mount	LFJ, LGC	Original x 1.5	Original x 1.5	Original / 1.5	Original / 1.5	4.9/0.2	-
2XE	2.0X	C-mount	LFJ, LGC	Original x 2.0	Original x 2.0	Original / 2.0	Original / 2.0	7.7/0.3	-
59 LGZ 814	1.4X	F-mount	LAF, LGB	Original x 1.4	Original x 1.4	Original / 1.4	Original / 1.4	-	-
59 LGZ 820	2.0X	F-mount	LAF, LGB	Original x 2.0	Original x 2.0	Original x 2.0	Original x 2.0	36/1.4	69/2.7

Adapter

The 59 LGT 101 adapter is used to convert from the F-mount (bayonet type) to the C-mount (1-inch, 32 TPI) thread for CCD cameras.

Part Number	Description
59 LGT 101	F-mount to C-mount Converter

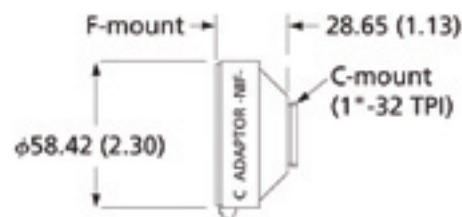

Accessories Continued

Right Angle Attachments

These attachments allow Invaritar™ lenses to view objects at right angles to the lens axis. The telecentricity, resolution, low distortion, and high contrast of the lenses are preserved. The attachments can be rotated 360 degrees around the lens optical axis to provide viewing in any direction.

Applications

These attachments are useful whenever it is difficult to point a lens directly at the object. They are especially helpful when adapting new optics to existing equipment, where space is limited.

Restrictions

- Right angle attachments are only usable only with specified lenses.
- Combined working distance is less than with lens alone.



Right Angle Attachments

Part Number	Description
59 LSF 101	Right-Angle Attachment for Macro Invaritar Lens Compatible with Part Number 59 LGM 601
59 LSF 401	Right-Angle Attachment for Invarigon-R Lenses

Macro Invaritar & Invarigon Lenses with Right Angle Attachments

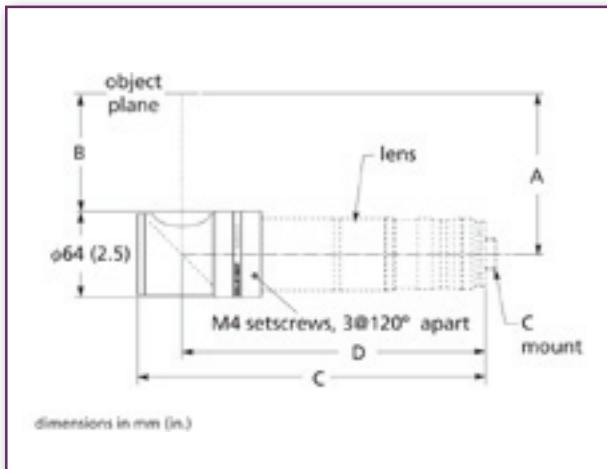

Right Angle Attachment Specifications

A (mm./in.)	B (mm./in.)	C (mm./in.)	D (mm./in.)	Use with Invarigon-R Macro Invaritar Lenses
Right Angle Attachment 59 LSF 101				
33.0/1.3	15.2/0.6	144.8/5.7	121.9/4.8	59 LGM 601
Right Angle Attachment 59 LSF 401				
76.2/3.0	45.7/1.8	195.6/7.7	162.6/6.4	59 LGU 042
116.8/4.6	86.4/3.4	243.8/9.6	210.8/8.3	59 LGU 050 + 59 LGZ 415
55.9/2.2	25.4/1.0	172.7/6.8	139.7/5.5	59 LGU 050
95.6/3.8	66.0/2.6	223.5/8.8	190.5/7.5	59 LGU 036 + 59 LGZ 415
116.8/4.6	86.4/3.4	246.4/9.7	213.4/8.4	59 LGU 031 + 59 LGZ 420
76.2/3.0	45.7/1.8	200.7/7.9	167.6/6.6	59 LGU 042 + 59 LGZ 415
96.5/3.8	66.0/2.6	226.1/8.9	193.0/7.6	59 LGU 036 + 59 LGZ 420
55.9/2.2	25.4/1.0	177.8/7.0	144.8/5.7	59 LGU 050 + 59 LGZ 415
76.2/3.0	45.7/1.8	203.2/8.0	170.2/6.7	59 LGU 042 + 59 LGZ 420
55.9/2.2	25.4/1.0	180.3/7.1	147.3/5.8	59 LGU 050 + 59 LGZ 420



Additional information and product specifications for telecentric lenses available at machinevision.navitar.com

Single-Sided Telecentric Lens Accessories

Fiber Bundle Collimator

This unit provides a large collimated beam for lighting machine vision applications. It accepts the output from a standard 59 QLS 700 fiber optic bundle. The uniform, collimated beam is useful for back lighting objects for gaging and feature inspection. The spectral content of the light is controlled by filtering at the fiber optic light source.

To make precise machine vision measurements, correct lighting is essential. Back lighting is useful for measuring the exterior dimension of opaque objects, or to measure the dimensions of holes through opaque objects. With diffuse back lighting, rays from the edges of the field can reflect from the edge of the object and confuse the image. A collimated light source eliminates the confusing rays. This is especially important when the object being measured is smooth, shiny or round.



Features

- Large clear aperture
- Compatible with 59 QLS 700
- Low divergence angle

Specifications

- Length: 190 mm
- Diameter: 53 mm
- Fiber input: 10 mm diameter
- Clear aperture: 35 mm
- Divergence angle: 11 arc min

Fiber Bundle Collimator

Part Number	Description
59 LGQ 035	Fiber Bundle Collimator C-mount

59 LGQ 035 Outline Drawing & Dimensions

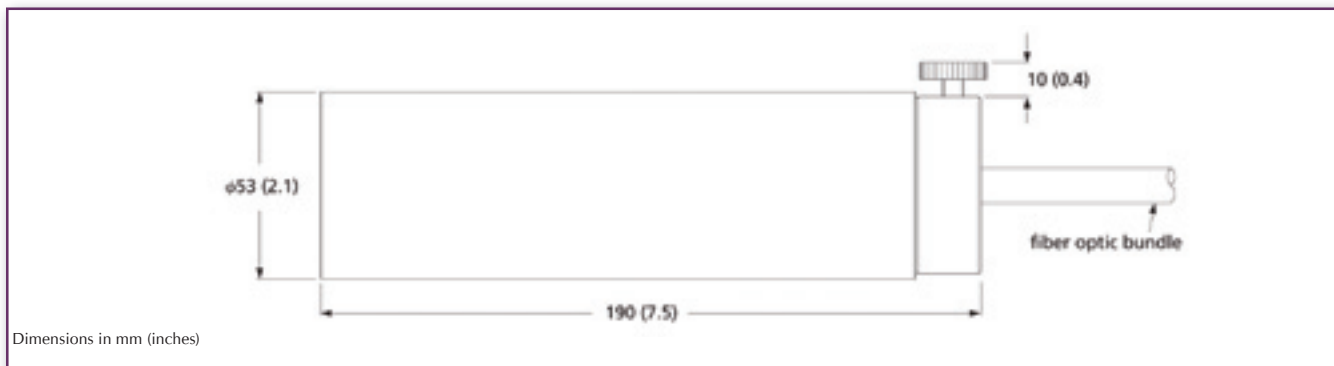

Accessories Continued

Lens Mounting Brackets

Use these brackets to clamp the Invaritar™ and Invarigon-R™ lenses to your application. This accessory clamps directly around the lens barrel and includes convenient standard-sized tapped mounting holes. The 59 LGP 717 is similar to the 59 LGP 403 and 59 LGP 414 except that it was designed for use with the 59 LGN series Extra Long Working Distance Macro Invaritar™ lenses.

Note: Clamping around the barrel immediately over the front lens element is not recommended. If mounting larger sized Invaritar base/attachment lens combinations, two clamps are recommended.



Features

- Clamps directly around lens barrel diameter for rigid attachment
- Rugged anodized-aluminum construction
- M6 or 1/4-20 tapped mounting holes

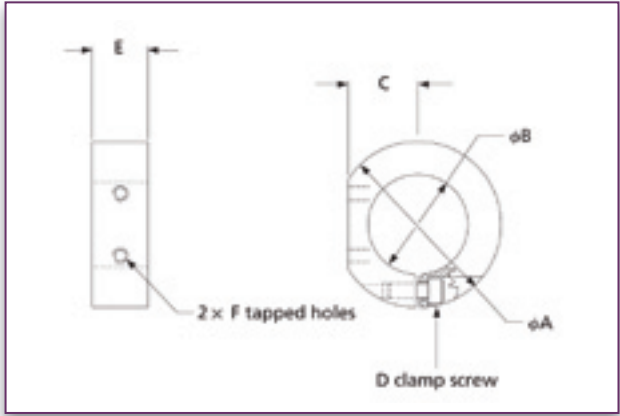

Lens Mounting Bracket Specifications

Part Number	Description	A (mm./in.)	B (mm./in.)	C (mm./in.)	Thread D	E (mm./in.)	Thread F
59 LGP 403	Standard Mounting Bracket	76.2 / 3.0	53.3 / 2.1	33.0 / 1.3	10-32	20.3 / 0.8	1/4 - 20
59 LGP 414	Mounting Bracket for Macro Invaritar	57.1 / 2.3	33.0 / 1.3	27.9 / 1.1	10-32	12.7 / 0.5	1/4 - 20
59 LGP 717	Mounting Bracket for ELWD Lenses	66.0 / 2.6	40.6 / 1.6	27.9 / 1.1	M6	22.9 / 0.9	M6



Additional information and product specifications for telecentric lenses available at machinevision.navitar.com

Video Telecentric Lenses

TC-5028

The Navitar TC-5028 telecentric lens is a 50 mm F/2.8 telecentric lens which reduces or eliminates viewing angle error and magnification error while providing high resolution and contrast with low distortion. This compact, lightweight lens can be used with 1/3", 1/2" and 2/3" format cameras and is usable from 0.5X to 1.0X, 1:1.

TC-5028 Video Lens Specifications		
Part Number	TC-5028	
Focal Length	50 mm	
Iris Range/ F-Stop	2.8 - Close	
Control	Iris	Manual
	Focus	Manual
	Zoom	N/A
Object Area at M.O.D (HxV)	2/3"	8.1 x 6.1
	1/2"	5.9 x 4.4
	1/3"	3.8 x 3.3
	1/4"	2.9 x 2.2
Focusing Range (meters)	0.5 - infinity	
Field Angle (HxV)	2/3"	10° 03' x 7° 33'
	1/2"	7° 19' x 5° 29'
	1/3"	5° 29' x 4° 07'
	1/4"	3° 39' x 2° 45'
Back Focal Length (mm)	32.5	
Filter Diameter	Ø37 P=0.75	
Mount	C-mount	
Weight (grams)	318	
Exit Pupil Position	48.1(from image plane)	
Distortion in TV	Less than 0.1%	
Vignetting	97%	
Filter Size	M37.5 x 0.5	

Specifications for Telecentric Use	
Magnifications	0.5 1.0X
Distortion at 0.5X	-0.3%
Distortion at 1.0X	Less than - 0.1%
Distance from Front Lens to Object	0.5X:115mm 1.0X:85mm



TC-5028 Outline Drawing with Dimensions

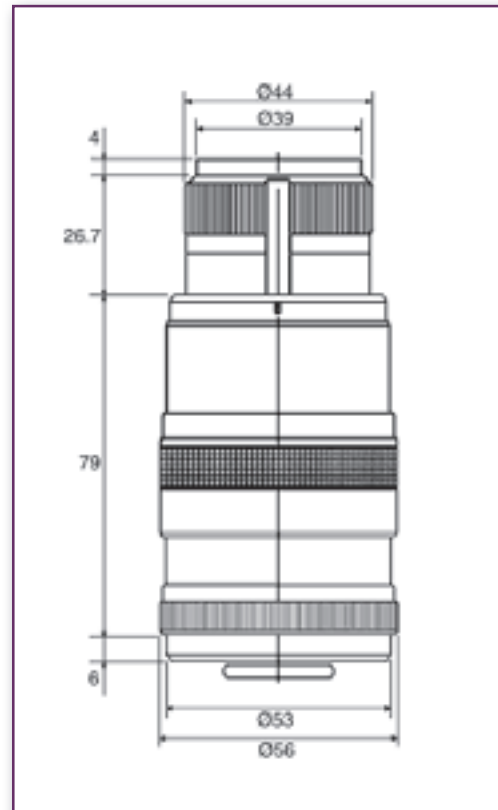

Video Telecentric Lenses

TEC-55

Navitar also offers the TEC-55 telecentric C-mount lens for 2/3" format cameras. This 55 mm F/2.8 telecentric lens maintains constant perspective and magnification.

Conventional lenses are often unable to accurately portray objects which are slightly out of focus or at different distances from the lens. Constant perspective and magnification are maintained with a telecentric lens, so the size of the image will not change.



TEC-55 Video Lens Specifications		
Part Number	TEC-55	
Focal Length	55 mm	
Iris Range/ F-Stop	2.8 - 32C	
Control	Iris	Manual
	Focus	Manual
	Zoom	N/A
Object Area at M.O.D (HxV)	2/3"	17 x 13
Focusing Range (meters)	0.14 - infinity	
Field Angle (HxV)	2/3"	9.2° x 6.97°
Back Focal Length (mm)	29.8	
Filter Diameter	Ø43 P=0.75	
Mount	C-mount	
Weight (grams)	320	
Exit Pupil Position	30.3 (from image plane)	

TEC-55 Outline Drawing with Dimensions

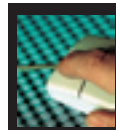
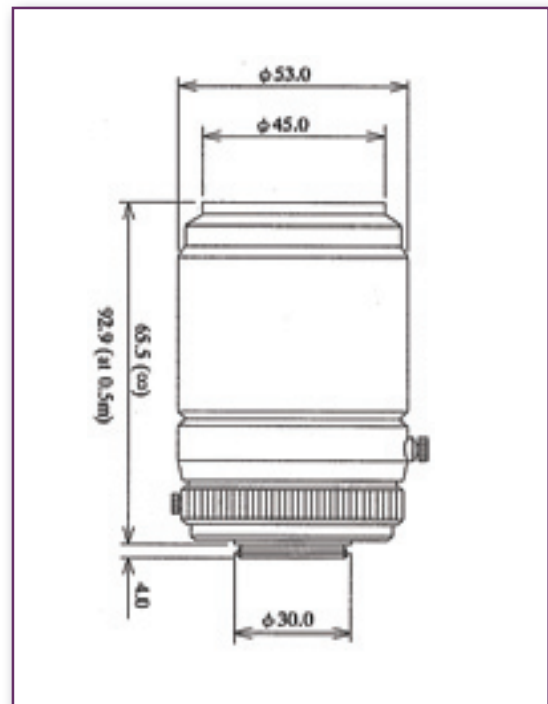

Additional information and product specifications for telecentric lenses available at machinevision.navitar.com

Double-Sided Telecentric Lenses

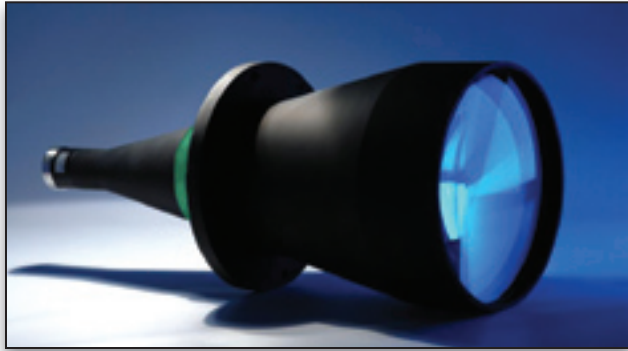

Object and Image Side Telecentricity

Navitar's Double-Sided Telecentric series of lenses are telecentric in *both the object and image space*, not just the object space as in the design of a normal telecentric lens. This design allows for telecentricity of less than 0.1% within the depth of field.

CCD and CMOS sensors continue to be developed with smaller and smaller pixels while increased electronic circuitry within the pixel further reduces the "fill factor." To help focus light onto individual pixels, camera makers are using micro lens arrays in their designs. While these individual lenses, over each pixel, serve to collect light, they also pose a challenge to the optics designer. These micro lenses are most effective when the incoming rays are five degrees or less, of normal. The telecentric cone of light is a major benefit in these situations.

Low Distortion, High Accuracy

Double-Sided Telecentric lenses are less prone to optical aberrations and geometrical distortions. Image sizes will not vary across the field due to positioning of the sensor. Gauging applications will benefit from a double-sided telecentric lens compared to a simple object side only telecentric system. Our lenses are designed to work with CCD and CMOS sensors up to 28.7mm diagonal. We offer lenses with magnification from 0.03X to 2.0X as well as large format lenses with magnification from 0.239X to 0.478X.

Mounting Options

The back focal length is adjusted on the basis of C-mount or F-mount standard. A spacer kit with instructions to fine tune the back focus for a specific need is included with each lens. Please call for mounting options.

Advantages of Double-Sided Telecentric Lenses

- Telecentric both in the object and in the image space.
- Less than 0.1% image distortion within the field depth at the field corners.
- No image vignetting.
- No parallax error.
- No change of magnification within the depth of field.
- MTF greater than 40% at 130 lines/mm.
- Uniform illumination.
- C or F mounts available.
- Specially designed illumination accessories.

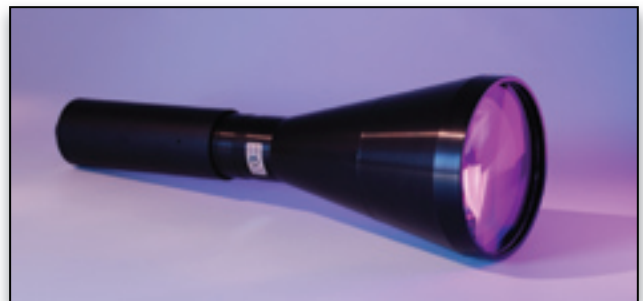

Sample Product Specification Sheet

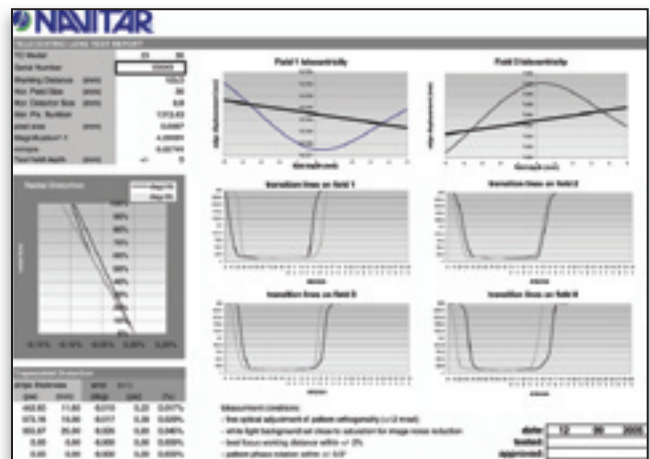

Double-Sided Telecentric Lenses for up to 2/3" Format Matrix

Part Number	Mag. (x)	Object Field ¹ (mm)			Optical Specifications						Dimensions		
		1/3" wxh 4.8 x 3.6	1/2" wxh 6.4 x 4.8	2/3" wxh 8.8 x 6.6	WD ² (mm)	F/# ³	MTF@ 70lp/mm%	Field Depth ⁴	Telecent. ⁵	Distortion (%)	Mount	Length ⁶	Diam.
1-17796	2.00	2.4 x 1.8	3.2 x 2.4	4.4 x 3.3	57.1	11	> 30	0.2	< 0.08	< 0.08	C	101.4	28
1-17797	1.33	3.6 x 2.7	4.8 x 3.6	6.6 x 5.0	61.2	11	> 30	0.5	< 0.08	< 0.08	C	78.5	28
1-17798	1.00	4.8 x 3.6	6.4 x 4.8	8.8 x 6.6	63.3	11	> 25	1	< 0.08	< 0.08	C	65	28
1-17800	0.40	12.0 x 9.0	16.0 x 12.0	diam = 16.5	45.3	8	> 40	4.5	< 0.1	< 0.08	C	92	37.8
1-17801	0.55	8.7 x 6.5	11.0 x 8.7	16.0 x 12.0	45.3	8	> 30	3	< 0.1	< 0.07	C	112	37.8
1-17802	0.27	18.0 x 13.5	24.0 x 18.0	diam = 24.8	69.2	8	> 45	10	< 0.1	< 0.08	C	122.5	44
1-17803	0.37	13.1 x 9.8	17.5 x 13.1	24.0 x 18.0	63.4	8	> 45	7	< 0.1	< 0.1	C	142	44
1-17804	0.13	36.0 x 27.0	diam = 36.0	n.a.	103.5	8	> 50	38	< 0.08	< 0.08	C	133	61
1-17805	0.18	27.0 x 20.3	36.0 x 27.0	diam = 37.1	103.5	8	> 40	22	< 0.08	< 0.1	C	148	61
1-17806	0.24	19.6 x 14.7	26.2 x 19.6	36.0 x 27.0	103.5	8	> 40	12	< 0.08	< 0.1	C	164.9	61
1-17808	0.13	36.0 x 27.0	48.0 x 36.0	diam = 49.5	134	8	> 40	24	< 0.1	< 0.1	C	180	75
1-17809	0.18	26.2 x 19.6	34.9 x 26.2	48.0 x 36.0	134	8	> 40	14	< 0.1	< 0.1	C	200	75
1-17810	0.11	42.0 x 31.5	56.0 x 42.0	diam = 57.8	159.3	8	> 50	45	< 0.08	< 0.08	C	205	80
1-17811	0.16	30.5 x 22.9	40.7 x 30.5	56.0 x 42.0	159.3	8	> 45	26	< 0.08	< 0.08	C	225	80
1-17812	0.08	64.0 x 48.0	diam = 64.0	n.a.	182.3	8	> 40	130	< 0.08	< 0.07	C	212	100
1-17813	0.10	48.0 x 36.0	64.0 x 48.0	diam = 66.0	182.3	8	> 50	60	< 0.08	< 0.07	C	227	100
1-17814	0.14	34.9 x 26.2	46.5 x 34.9	64.0 x 48.0	182.3	8	> 50	36	< 0.08	< 0.07	C	245.5	100
1-17815	0.12	39.3 x 29.5	52.4 x 39.3	72.0 x 54.0	227.7	8	> 40	48	< 0.08	< 0.07	C	300	120
1-17816	0.08	60.0 x 45.0	80.0 x 60.0	diam = 82.5	227.7	8	> 50	90	< 0.08	< 0.1	C	272	120
1-17817	0.11	43.6 x 32.7	58.2 x 43.6	80.0 x 60.0	227.7	8	> 50	57	< 0.08	< 0.1	C	272	120
1-17818	0.10	46.4 x 34.8	61.8 x 46.4	85.0 x 63.8	280.6	8	> 45	60	< 0.08	< 0.08	C	346	146
1-17819	0.05	96.0 x 72.0	diam = 96.0	n.a.	280.6	8	> 50	240	< 0.08	< 0.1	C	302	146
1-17820	0.07	72.0 x 54.0	96.0 x 72.0	diam = 99.0	279.6	8	> 45	120	< 0.08	< 0.08	C	318	146
1-17821	0.09	52.4 x 39.3	69.8 x 52.4	96.0 x 72.0	279.6	8	> 40	70	< 0.08	< 0.08	C	338	146
1-17822	0.08	60.0 x 45.0	80.0 x 60.0	110.0 x 82.5	336.5	8	> 40	90	< 0.08	< 0.07	C	431	185
1-17823	0.05	90.0 x 67.5	120.0 x 90.0	diam = 123.8	336.5	8	> 45	180	< 0.08	< 0.1	C	402	185
1-17824	0.07	65.5 x 49.1	87.3 x 65.5	120.0 x 90.0	336.5	8	> 35	105	< 0.08	< 0.1	C	422	185
1-17825	0.07	70.9 x 53.2	94.5 x 70.9	130.0 x 97.5	398	8	> 40	150	< 0.08	< 0.1	C	490	200
1-17826	0.04	108.0 x 81.0	144.0 x 108.0	diam = 148.5	398	8	> 35	260	< 0.08	< 0.08	C	483	200
1-17827	0.06	78.5 x 58.9	104.7 x 78.5	144.0 x 108.0	398	8	> 40	160	< 0.08	< 0.08	C	628	200
1-17828	0.05	93.8 x 70.4	125.1 x 93.8	172.0 x 129.0	531	8	> 40	240	< 0.08	< 0.1	C	628	260
1-17829	0.03	144.0 x 108.0	192.0 x 144.0	diam = 198.0	531	8	> 45	360	< 0.08	< 0.08	C	600	260
1-17840	0.05	104.7 x 78.5	139.6 x 104.7	192.0 x 144.0	531	8	> 35	240	< 0.08	< 0.08	C	618	260
1-17841	0.04	109.1 x 81.8	145.5 x 109.1	200.0 x 150.0	500	8	> 40	310	< 0.08	< 0.1	C	785	330
1-17842	0.04	130.9 x 98.2	174.5 x 130.9	240.0 x 180.0	500	8	> 45	380	< 0.08	< 0.08	C	778	330

Large Format Double-Sided Telecentric Lenses Matrix

Part Number	Mag. (x)	Object Field ¹ (mm)			Optical Specifications						Dimensions		
		4k x 7µm	2k x 10µm	2k x 7µm	WD ² (mm)	F/# ³	MTF@ 70lp/mm%	Field Depth ⁴	Telecent. ⁵	Distortion (%)	Mount	Length ⁶	Diameter
1-17843	0.478	60	43	30	230	9	> 30	4	< 0.08	< 0.08	F	460	100
1-17844	0.36	80	57	40	243	9	> 30	7	< 0.01	< 0.10	F	460	120
1-17845	0.239	120	86	60	250	9	> 30	15	< 0.01	< 0.15	F	460	146

¹For the fields with the indication "diam =" the image of a circular object is inscribed inside the short detector side.

²Working distance: Best focus front lens to object distance. Set this distance within +/- 3% of the nominal value to minimize distortion.

³Working F/#: The real F/# of a lens when used as a macro lens with a smaller aperture can be supplied upon request.

⁴Out of this interval the CTF contrast falls below 50% of the nominal value; the field depth can be increased by a smaller diaphragm, available on request.

⁵Maximum slope of principal rays inside the lens: Turned in millirads. Tells which is the maximum measurement error for any millimeter of object displacement.

⁶Measured from the end of the mechanics to the camera flange.

Double-Sided Telecentric Illumination Accessories

Illumination has proven to be one of the most important components when designing a successful imaging system. Navitar thoroughly understands that the correct lighting will enhance the performance of your vision system. We offer three LED lighting options specially designed for Double-Sided Telecentric lenses. Our LED Ring Light and Coaxial Diffusive LED lighting accessories were designed for the standard working distances that most of our customers use. Collimated LED accessories are a popular choice for backlighting. All of these components are low profile and provide bright, even illumination to compliment the performance of our lenses.

LED Ring Light Illumination

Diffusive LED ring lights are specifically designed to fit our Double-Sided Telecentric lenses. The illuminating geometry is tailored for the specific working distance and aperture.

LED Ring Light Features:

- Special mechanical interfaces.
- Different types of diffusers.
- Available with red or white LEDs.
- External power supplies.

LED Ring Light Specifications

Part Number	Light	Dimensions (mm)			Power Supply
		Outer Diameter	Lens Opening	Height	
1-17790	White	72	28	36	24V, 300mA
1-17791	Red	72	28	36	24V, 300mA
1-17792	White	119	61	36	24V, 600mA
1-17793	Red	119	61	36	24V, 600mA
1-17794	White	160	100	38	24V, 900mA
1-17795	Red	160	100	38	24V, 900mA

Coaxial Diffusive LED Illumination

Diffusive coaxial lights are designed to be used in combination with our Double-Sided Telecentric lenses to image objects with holes or highly reflective surfaces. The target is illuminated in the same direction of the image capture allowing highly 3D-shaped parts to be imaged and shadows removed.

Coaxial Diffusive LED Features:

- Built-in electronics for stability control.
- Compact design with thermal management.
- Cost-effective.
- A range of sizes to select from.

Coaxial Diffusive LED Specifications

Part Number	Window (mm) (LxH)	Dimensions (mm) (LxWxH)	Spectrum			Illuminance at Working Distance		
			Color	K	Peak wv	50mm	100mm	200mm
1-17786	50.0 x 50.0	108.0 x 57.0 x 62.0	Red	-	625nm	4700	980	310
1-17787	50.0 x 50.0	108.0 x 57.0 x 62.0	White	5500	-	3300	800	250
1-17788	82.0 x 82.0	155.0 x 104.0 x 93.0	Red	-	625nm	4500	910	270
1-17789	82.0 x 82.0	155.0 x 104.0 x 93.0	White	5500	-	2800	750	210

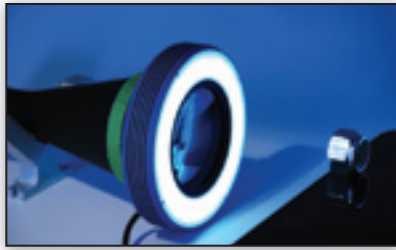

LED Ring Light



Coaxial Diffusive LED



Collimated LED

Collimated LED Illumination

Our collimated light sources are the best choice for back lighting objects imaged through a telecentric lens for high precision or speed applications, as all of the light exiting the collimator enters the lens and enters the sensor.

Collimated LED Specifications

Part Number	Beam Diameter (mm)	Length (mm)	Diameter (mm)	LED Color
1-17765	20	87	38	White
1-17766	30	100	44	White
1-17767	45	139	61	White
1-17846	60	139	75	White
1-17768	70	191	80	White
1-17769	80	219	100	White
1-17770	100	265	116	White
1-17771	120	310	143	White
1-17772	150	396	180	White
1-17773	180	456	200	White
1-17774	250	592	260	White
1-17775	300	747	322	White
1-17776	20	87	38	Red
1-17777	30	100	44	Red
1-17764	45	139	61	Red
1-17847	60	139	75	Red
1-17778	70	191	80	Red
1-17779	80	219	100	Red
1-17780	100	265	116	Red
1-17781	120	310	143	Red
1-17782	150	396	180	Red
1-17783	180	456	200	Red
1-17784	250	592	260	Red
1-17785	300	747	322	Red

Collimated LED Features:

- Eliminates border effects that can warp the perceived size of an image.
- Efficient use of light.



Additional information and product specifications for telecentric lenses available at www.machinevision.navitar.com

Telecentricity FAQ's

• • • What is Telecentricity?

Telecentricity is a distinctive property of certain multi-element lens designs in which the chief rays (the rays through the center of the entrance or exit pupil), for all points across the object or image, are parallel to the optical axis.

• • • Now, what is Telecentricity in English?

Telecentricity is all a matter of perspective distortion, which is a variation in magnification with distance. A railroad track that shrinks, or a tall building that gets narrower with height, are both everyday examples of this. Hold one thumb close to the eye and the other at arms length. One looks smaller than the other - your brain knows that's not so, however, a vision system doesn't. The telecentric lens makes all objects, within the "depth of field" of the lens, appear to be equidistant from the lens, thereby eliminating the variation in magnification with distance (see diagram at right).

• • • What are the benefits of using a Telecentric Lens?

Telecentric lenses provide constant image magnification as object distance varies - virtually eliminating perspective angle error. With a telecentric lens, objects inside deep holes are visible throughout the field, undistorted, therefore, these lenses are extremely useful for inspecting three-dimensional objects or scenes where image size and shape accuracy are critical.

• • • Do I need special illumination with a Telecentric lens?

Yes, if you want to derive the full benefit of telecentricity. Both incident and transmitted illumination should meet certain collimation criteria.

• • • How is the degree of telecentricity determined?

The degree of telecentricity is measured by the chief ray angle in the corner of the field. Telecentric lenses have chief ray angles of less than 0.5 degrees - some even have less than 0.1 degree. In comparison, a standard commercial lens may have chief ray angles of 10 degrees or more.

• • • Will using a Telecentric lens improve my depth of field?

No, telecentricity will keep the magnification constant through the depth of field. However, the focus will soften as with any lens. The depth of field will still be determined by the system's F/#.

• • • Are Telecentric lenses available with Zoom features?

Yes, Navitar's 12X Telecentric Zoom system allows users to reach a true telecentric condition to within less than 0.3 degrees while maintaining constant perspective and magnification. The 12X Telecentric Zoom provides field coverage from 50 mm down to 4 mm and with coaxial illumination, allows clear viewing, even when working with mirror-like surfaces.

• • • What is the difference between a Double-Sided Telecentric lens and a standard Telecentric Lens?

Double-Sided Telecentric lenses provide both image and object side telecentricity. With the single telecentric lens, the rays at the image plane are still coming in at strong angles. If we "double up" on the lenses, we now have telecentric performance front and back. The resulting system is less prone to optical aberrations and geometrical distortions. Image size will not vary across the field due to positioning of the sensor.

Modern sensor pixels are both getting smaller and more cluttered up with electronic circuitry. As light collection is normally a function of active area, manufacturers are adding micro lenses over each pixel to aid in the collection of light. These micro lenses are most effective when the incoming rays are 5 degrees, or less, off normal. The telecentric cone of light is a major benefit in these situations.

